

Installation and Commissioning Instructions  
Combined Motor Start and Braking Devices  
VC II 230 - 3 ... 7,5  
VC II 400 - 5,5 ... 15

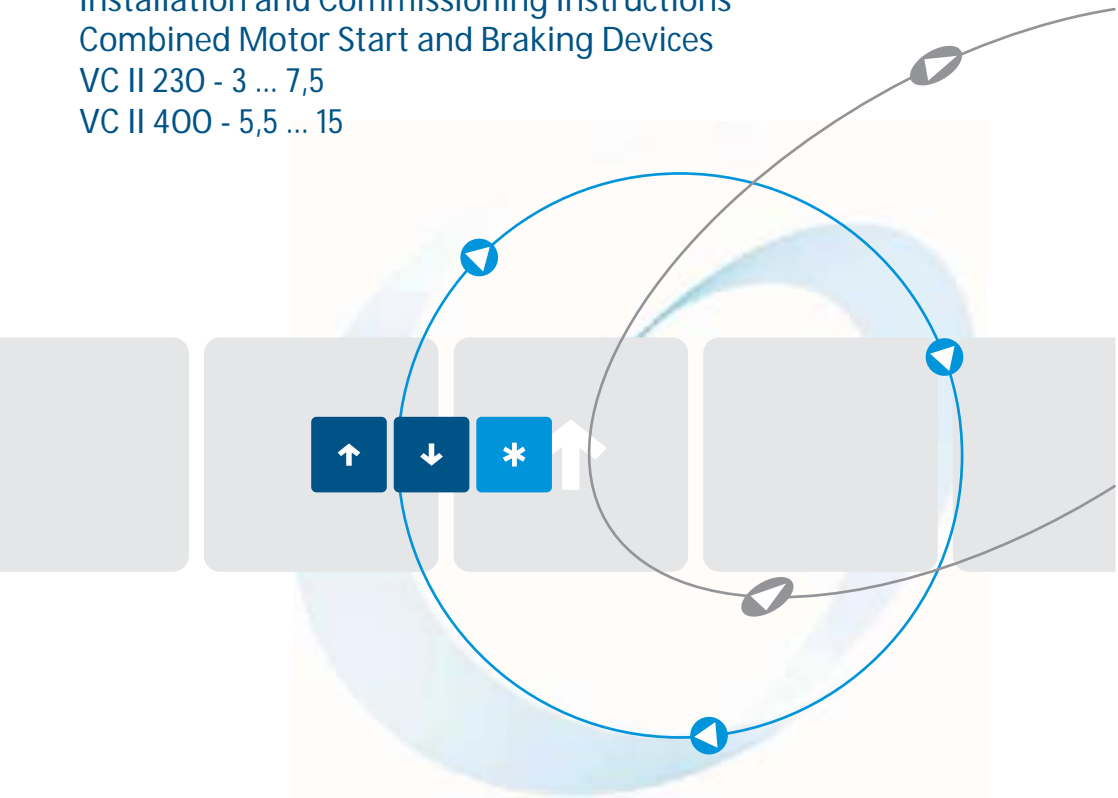

as per 09/11 16120.10002

<b>Table of Contents</b>	<b>Page</b>
1. Safety notes	3
2. Conformity	3
3. General description	4
4. Usage to the intended purpose	4
5. EC Declaration of Conformity	5
6. Block diagram	6
7. Functional description (see connection diagram)	6
7.1 LED indicators	8
7.2 Potentiometers	9
7.3 Monitoring functions	9
7.4 Option „B“ – Wide-voltage-range	10
8. Technical data	11
8.1 Safety Ratings	11
8.2 Environmental conditions	12
8.3 Technical data - special devices	12
8.4 Max. Switching frequency	12
9. Commissioning	13
9.1 Mounting instructions	13
9.2 Connection	14
9.3 Parameter settings	14
10. Dimensioning of pre-fuses	17
10.1 Note on UL/cUL-requirements	19
11. Installation guideline	19
11.1 Dimensions	19
11.2 General connection diagram	20
11.3 Connection diagram for special devices VCII 480-...B SO9/24VAC	21

---

These commissioning instructions were prepared with great care. Nevertheless, PETER electronic GmbH & Co. KG does not assume liability for damage resulting from mistakes possibly contained in this manual. Technical changes that serve to improve the product are subject to change without notice.

### Notes and symbols used in these instructions

**Note:** Notes explain the advantages of certain adjustments or settings and help you to make use of the device in the best possible way.



**Warning notices: Read them carefully and follow them strictly!**

Warning notices are indicated in order to protect you against danger or to help you to prevent the device from being damaged.



**Caution: Danger to life through electric shock!**

When you see this sign, always make sure that the device is de-energized and secured against unintentional energizing.

---

## 1. Safety notes



The described devices are electrical equipment for use in industrial electrical power installations. An impermissible removal of the covers during operation can cause serious damage to your health, since these devices contain live parts with high voltages.

Adjustment work may only be performed by trained staff observing the safety regulations. Assembly and mounting work may only be carried out with the equipment deenergized.

Make sure that all drive components are properly earthed.

Please read these commissioning instructions carefully before putting the device into operation.

Besides, the user must ensure that the devices and associated components are fitted and connected in accordance with the applicable local, legal and technical regulations. The VDE-regulations VDE 0100, VDE 0110 (EN 60664), VDE 0160 (EN 50178) , VDE 0113 (EN 60204, EN 61310), VDE 0660 (EN 50274) plus the appropriate regulations of the TÜV (Technical Control Association) and the trade associations apply in Germany.

The user must ensure that the drive turns into a safe operating state following a device failure, in the event of maloperation, or if the control unit has failed etc..

**Caution:** Even if the motor is at rest, it is **not** physically separated from the mains.

## 2. Conformity

In industrial linguistic usage the drive controllers of the type series VersiComb II are called "devices" , however, in the sense of the "law on the safety of equipment", the "EMC-law" or the "EC machinery directive" they are not devices or machines ready for use or connection but they are components. It is only possible to define their final function, when these components are integrated into the design and construction of the user.

**To be able to use the devices to their intended purpose, it requires power supply networks according to DIN EN 50160 (IEC38).**

The user takes the responsibility that the user's design and construction comply with the applicable legal provision.

The commissioning is strictly forbidden as long as the conformity of the final product with the guidelines 2006/42/EC (Machinery directive) and 2006/95/EC (Low voltage directive) is not proved.

---

### 3. General description

The devices of the VersiComb II type enable soft start and non-wearing braking of three-phase asynchronous motors. Their advantages in comparison with direct-on-line starting or star-delta starting are a torque increase without jerk and a current reduction during the starting phase. The VersiComb-devices are used for drives that require a soft starting torque in order to protect the drive components and which, for safety and functional reasons, have to be reliably slowed down.

When the soft start is over, the power semiconductors are bypassed by integrated relays. After the motor contactor has opened, braking is initiated. An integrated standstill detection switches the braking current off after the motor has come to a standstill. The fault signaling contact indicates if the motor has not come to a standstill within the maximum braking time.

Since the standard EN 954-1 calls for a tried and tested component (contactor) in order to cut the drive power off, a motor contactor has to be connected in series before the combined soft start and braking device.

#### Special features

- controlled by microcontroller
- two-phase controlled soft start
- integrated bypass relays
- reduction of starting current peaks
- DC braking via controlled thyristor bridge
- integrated braking contactor
- integrated standstill detection
- monitoring of deceleration time
- suitable for all asynchronous motors
- for snap-on mounting onto 35mm DIN rail
- wide-voltage-range - Option „B“

### 4. Usage to the intended purpose

The devices of the VersiComb II series are electrical equipment that is used in industrial electrical power installations. They are designed for application in machines, in order to reduce the starting torque and starting current peaks and to slow down centrifugal masses on drives with three-phase induction motors.

#### Typical applications

- vibrators
  - wood working machines
  - centrifuges
  - drives with large rotating masses
  - belt drives
-

**5. EC Declaration of Conformity**

**EC Declaration of Conformity** 

The manufacturer / company placing the product on the market  
(authorized representatives of the manufacturer / companies placing the product on the market  
that are established within the Community)

Name / Address: Peter Electronic GmbH & Co.KG  
Bruckäcker 9  
92348 Berg  
Germany

hereby declares that the following product (device, component, unit) in the version as supplied

**Product designation:** **Combined Motor Start and Braking Device**  
Serien / type designation: VC II 230/400-3...15  
Article group: 2612..., 2613..., 2615...  
Year of manufacture: 2004

complies with the provisions of the following EC-directives:

**2004/108/EG** concerning Electromagnetic compatibility and **2006/95/EG** concerning Electrical equipment designed for use within certain voltage limits

**The following harmonized standards have been applied:**

EN 60947-1: 2008	Low-voltage switchgear and controlgear General rules	EN 60947-4-2: 2007	Low-voltage switchgear and controlgear Contactors and motor-starters - AC semiconductor motor controllers and starters
------------------	---	--------------------	--

This EC Declaration of Conformity is no longer valid, if the products is modified or changed  
without our agreement.

This declaration is issued under the sole responsibility of the signatory.

Berg, 05.08.2009  
(place, date)

Dr. Thomas Stiller, Managing Director  
(signatory and function of the signatory)

  
(signature)

## 6. Block diagram

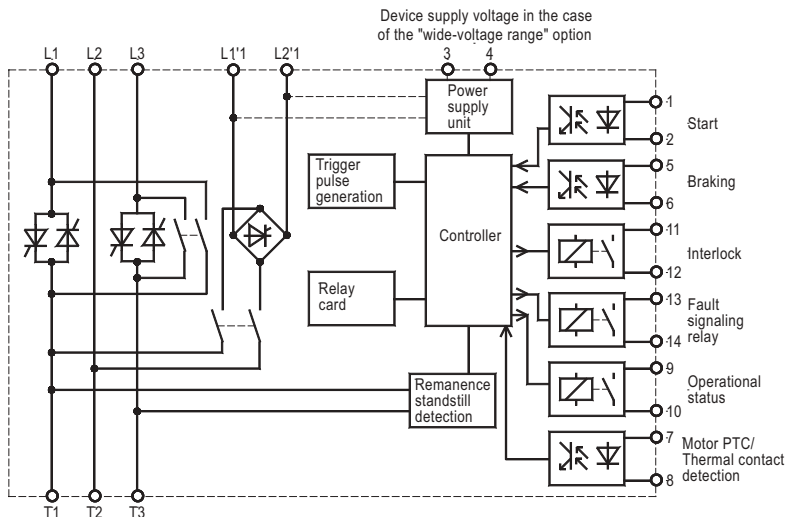

## 7. Functional description (see connection diagram)

After switching on the operating voltage on L1', L2' (3, 4 in the case of wide-voltage-range devices, option „B“), the main contactor interlock on the terminals 11, 12 and the operational status contact on the terminals 9, 10 as well as the fault signaling contact on the terminals 13, 14 are closed. The motor can be started by pressing the ON-key.

After the start, the motor voltage is changed in two phases (L1 and L3) by a generalized phase control and power semiconductors. Starting out from an adjustable starting voltage (potentiometer „M“) the motor voltage is steadily increased. The motor torque rises over the adjusted acceleration time (potentiometer „t“) according to a ramp function up to the maximum value. When the starting time is over, the power semiconductors are bypassed by integrated relays and the motor is directly supplied with power from the mains.

The fully automatic run of the braking interval starts with the switch-off of the motor contactor K1 which thereby closes the contact 5, 6. During braking, the motor contactor is interlocked via the contact 11, 12. After a delay time which, dependent on the amount of the remanent voltage of the the motor, optimizes itself, the integrated braking contactor pulls in. Afterwards, an adjustable d.c voltage is applied to the motor winding. The magnetic field resulting from this has a braking effect on the still rotating rotor. The d.c. voltage is generated with a thyristor phase control. Special circuits protect the power semiconductors against overvoltage. With the potentiometer „I“ the braking torque can be adjusted in wide ranges. Experience shows that a braking current 2.5 times as high as the rated motor current has a good braking effect.

Approx. 1.5s after a motor standstill has been detected, the integrated standstill detection (adaptable to the drive via potentiometer „n0“) switches the braking current off.

If during the maximum braking time (10s in the case of standard devices) no motor standstill is detected, the fault signaling contact on the terminals 13, 14 opens and the red „fault“-LED lights up. When the motor is restarted, this fault indication will be reset. If this fault occurs 3 times in succession during an operation phase, the VersiComb II goes into fault condition. It is no longer possible to switch the drive on.

Exceeding of the max. heat sink temperature, a defective or charred ON-key, trigger faults or synchronization errors as well as reaching of the max. motor temperature (if a motor PTC or a thermal contact (bimetal) is connected to 7, 8) also cause the VersiComb II to go into this fault condition which can only be left by remedying the fault and carrying out a mains reset.

By switching the device on, the operational status contact on the terminals 9, 10 is closed, and it is open from the beginning of the soft start until the end of braking by the **standard devices**.

By the **VC II 400-5,5 ... 15 SO1** devices the operational status contact on the terminals 9,10 is closed from the end of the soft start until the beginning of the braking.

By the **VC II 400-5,5 ... 15 SO3, SO9** devices the operational status contact on the terminals 9,10 is closed from the beginning of the soft start until the end of the braking.

**Warning**

To protect the motor and the braking electronics, it is necessary, when putting the device into operation, to check the braking current with a true r.m.s. measuring instrument. Simple multimeters and clamp-on probes produce wrong measurements, since they are only suitable für pure sine-wave forms and not for phase control.

If, due to the fact that heavy rotating masses are to be slowed down, it is not possible to bring the motor to a standstill with the permissible maximum braking current (rated device current), a device of a higher performance category has to be used.



### 7.1 LED indicators

<b>LED – line (green)</b> - Illuminated	<b>Operational state</b> - Mains voltage is applied, VersiComb II is ready.
--	---

<b>LED – bypass (yellow)</b> - Changes flashing frequency - Illuminated - Flashing 2x <sup>a</sup> - Flashing 3x <sup>a</sup> - Flashing 4x <sup>a</sup> - Flashing 5x <sup>a</sup> - Flashing 7x <sup>a</sup> - Flashing 9x <sup>a</sup>	<b>Operational state</b> - Motor is in the start-up phase - Start-up is finished - Heat sink or motor temperature too high - Microcontroller error - max. Braking time exceeded (3x in succession) - Trigger failure - Mains fault or synchronization error - Start contact defective/charred
---	---

a. ... repeatedly with a short pause

<b>LED – fault (red)</b> - Illuminated	<b>Operational state</b> - Fault, observe flash. indication of bypass-LED
---	--

If, after braking, the „fault“ LED is illuminated and the „bypass“ LED is not flashing, no motor standstill has been detected. The motor standstill threshold detection has to be adapted as described in the chapter „Adjusting the standstill threshold“, on page 14.

## 7.2 Potentiometers

On the front panel there are 4 potentiometers enabling the following adjustments.

„t“ **Adjusting the starting time:**

The starting time can be adjusted in a range from 0.5 – 16s. The adjustment is linear.

„M“ **Adjusting the starting torque:**

The starting torque can be adjusted in a range from 0 – 80% of the maximum value. The adjustment is linear.

„I“ **Adjusting the braking current setpoint value:**

The braking current can be adjusted in a range from 0 – 100% of the rated device current. The adjustment is linear. From the position of the potentiometer it is possible to infer the amount of the braking current.

One graduation mark equals 10% of the rated device current.

„n0“ **Adapting the standstill threshold in the case of standstill-dependent braking:**

The potentiometer „n0=0“ can be used if the braking current is switched off before the motor has come to a standstill.

„tbr“ In the case of **special devices of the SO4 type**, no standstill is detected. With the potentiometer „t br“, the braking time can be adjusted between 0-25s. The adjustment is linear. The braking time adjusted on „t br“ becomes effective only after completion of acceleration, and after switching of the by-pass relays. If, after mains reset, braking is initiated during start-up, a braking time of 20s is automatically adjusted.

## 7.3 Monitoring functions

### Heat sink temperature

Exceeding of the permissible temperature causes a fault.  
The motor cannot be started anymore.  
Reset after cooling and mains reset.

### Motor temperature

Exceeding of the permissible temperature causes a fault.  
The motor cannot be started anymore.  
Reset after cooling and mains reset.

### Trigger failure or synchronization error

A trigger failure/synchronization error causes a fault.  
The motor cannot be started anymore.  
Reset after fault recovery and mains reset.

Possible fault causes:

- mains phases missing
- motor connection missing

If, despite the fact that the device is correctly connected and the mains voltage is applied, the fault cannot be remedied, the device is defective.

---

**Check of the start key**

A defective or charred key causes a fault.  
The motor cannot be started anymore.  
Reset after fault recovery and mains reset.

**Exceeding the permissible max. braking time**

If, after the max. braking time is over, no motor standstill is detected, this leads to a fault (red „fault“-LED is illuminated).

When restarting the motor, this fault will be reset.

If this fault occurs 3 times in succession during an operation phase, the motor cannot be started anymore.

Reset after fault recovery and mains reset.

Possible fault causes:

- the adjusted braking current is too small
- despite the fact that the maximum braking current is adjusted, the motor or the centrifugal mass on the motor is too large

In the latter case, an incorrect device rating was chosen. A device with a higher braking current or a device featuring a longer braking time has to be used, in so far as this is permissible for safety and functional reasons.

**7.4 Option „B“ – Wide-voltage-range**

With this option, it is possible to use VersiComb II-devices within a mains voltage range from 200...480V.

This requires a device supply voltage of 24V AC or 230V AC which has to be connected to the terminals 3, 4.

If VersiComb II is used as a wide-voltage-range device, the control voltage has to be in the same range as the supply voltage.

<b>Device supply voltage</b>	<b>Control voltage</b>
- 24V AC  - 230V AC	- 24V DC In the case of a control voltage of 24VAC, a special device will be required. - 230V AC

**Note:** In the case of standard devices this option is not available, even if the terminals are present.

The requested option and the device supply voltage to be used have to be expressly indicated when placing the order.

## 8. Technical data

Type designation	VersiComb II			
	230-3 400-5.5 480-5,5	230-4 400-7.5 480-7,5	230-5,5 400-11 480-11	230-7.5 400-15 480-15
Mains / Motor voltage acc. to DIN EN 50160 (IEC 38)	3AC 230V ± 10% 50/60Hz 3AC 400V ± 10% 50/60Hz 3AC 480V ± 10% 50/60Hz			
Rated device current Starting section	12A	15A	25A	32A
Rated device current Braking section	25A	35A	45A	55A
Motor rating at 400V	5.5kW	7.5kW	11kW	15kW
min. Motor load	40% of the device rating			
Starting time	0.5 ... 16s			
Starting torque	0 ... 80%			
Braking voltage	0 ... 230V at 230V 0 ... 400V at 400V 0 ... 480V at 480V			
max. Braking time	10s			
Delay for reduction of residual e.m.f.	self-optimizing (100 ... 1500ms)			
max. Switching frequency with a starting time and braking time up to 10s each	30/h	30/h	30/h	20/h
max. Cross-sectional area for connect. (Tightening torque of terminals)	Control terminals 2.5mm <sup>2</sup> (0.5 - 0.6 Nm) Power terminals 4mm <sup>2</sup> flexible; 6mm <sup>2</sup> rigid (0.5 - 0.6 Nm)			
I <sup>2</sup> t-values of power semiconductors, Starting section	1350A <sup>2</sup> s	6050A <sup>2</sup> s	7200A <sup>2</sup> s	7200A <sup>2</sup> s
I <sup>2</sup> t-values of power semiconductors, Braking section	1350A <sup>2</sup> s	1350A <sup>2</sup> s	6050A <sup>2</sup> s	7200A <sup>2</sup> s
Contact rating of output relays	3A/250V AC			
Weight	1.5 kg			

### 8.1 Safety Ratings

Performance Level (EN ISO 13849-1)	PL b
Category (EN ISO 13849-1)	B
PFH [ 1/h ]	4,23E-06
MTTFd [ years]	100

## 8.2 Environmental conditions

Storage temperature	-25 ... 75°C
Operating temperature	0 ... 45°C up to an altitude of 1000m
Degree of protection	IP 20
Environment	Overvoltage category III (TT / TN-systems) Pollution degree 2

## 8.3 Technical data - special devices

If deviating from the standard device

Type designation		VersiComb II			
		230-3 400-5.5 480-5,5	230-4 400-7.5 480-7,5	230-5,5 400-11 480-11	230-7.5 400-15 480-15
Rated device current Braking section	SO9 =	45A	60A	75A	-
Starting time	SO2 = SO8 = SO9 =	0.5 ... 30s 0.5 ... 32s 5.5 ... 21s			
max. Braking time	SO2 = SO9 =	60s 15s			
max. Switching frequency	SO2 = SO8 = SO9 =	5/h 25/h 12/h	5/h 25/h 12/h	5/h 25/h 12/h	5/h 25/h -
I <sup>2</sup> t-values of power semiconductors, Starting section	SO9 =	6050A <sup>2</sup> s			
I <sup>2</sup> t-values of power semiconductors, Braking section	SO9 =	6050A <sup>2</sup> s	6050A <sup>2</sup> s		

## 8.4 Max. Switching frequency

The permissible switching frequency depends on the adjusted starting torque, starting time, the adjusted braking current and braking time.

During soft start and braking, the power semiconductors in the device are loaded. As a result, the temperature of the semiconductors increases. For this temperature not to destroy the semiconductors but to be passed on to the heat sink, it is necessary that the switching frequency permissible for the devices is not exceeded.

The values indicated in the tables refer to an operation at maximally possible acceleration and deceleration times and at maximum braking current.

## 9. Commissioning

The device is to be put into operation in 3 steps:

1. Mounting
2. Connection and
3. Parameter setting

### 9.1 Mounting instructions



#### **Caution: Danger to life through electric shock!**

The following conditions are to be complied with in order to ensure a safe and reliable operation of the VersiComb II:

1. The device series VersiComb II is to be used under conditions of the overvoltage category III.
2. Make sure that pollution degree 2 or better, in accordance with IEC664, is complied with.
3. The device is to be installed into a housing (min. degree of protection: IP54).
4. The device must be operated without being exposed to contamination by water, oil, carbon deposits, dust, etc..



#### **Warning:**

To avoid heat concentrations, a distance of at least 50mm is to be kept between cable duct and device.

---

## 9.2 Connection

VersiComb II is to be installed according to the attached connection diagram.  
For other connections please consult PETER electronic GmbH & Co. KG.

**Note:** Prior to putting the device into operation, the wiring is to be checked.

The usual line and motor protective measures are to be applied. In the case of high switching frequency it is advisable to monitor, as a motor protective measure, the winding temperature, since the thermal stress increases and the switching frequency permissible for the motor decreases.

If motor temperature monitoring is not planned to be implemented, the terminals 7, 8 have to be connected.

**Note:** To ensure reliable and safe function it is necessary to comply with the interlocking conditions:

1. To initiate braking, it requires a potential-free normally closed contact of the main contactor, i.e., when the motor contactor is dropped out, the terminals 5, 6 are connected.
2. The interlocking contact, terminals 11, 12, has to be looped into the control circuit of the motor contactor K1, so that the motor contactor **cannot** pull in during braking.

The 24V DC voltage supplied by the device both for checking the normally closed contact of the main contactor and for motor-PTC detection is **not** a protection voltage or functional extra-low voltage and must only be used to its intended purpose.



### Caution:

The motor is **not** physically separated from the mains.

## 9.3 Parameter settings

Sequence of steps during commissioning:

1. Disconnect the plant/system from the supply mains.
  2. Connect an amperemeter between the device (terminal „T1“) and motor terminal „U“. A moving-iron instrument is required in order to adjust the braking current. Clamp-on probes or digital multimeters can be used only if they are capable of measuring the „true r.m.s.“.
  3. Turn potentiometer „t“ clockwise to right stop (position 10 on the scale)
  4. Turn potentiometer „M“ counter-clockwise to left stop (position 0 on the scale)
  5. Turn potentiometer „I“ to a position in the left third (position 2 on the scale)
  6. Turn potentiometer „n0“ to left stop (position 0 on the scale)
  7. Switch on the mains
  8. Start motor by pressing the ON-key
-

**Note:** When setting up a machine or during commissioning, it is possible to carry out 5 starts or braking operations in succession, i.e., with rated device current and at a braking time of 10s. After such operating conditions, however, the device needs a recovery time of 20 minutes.

### Adjusting soft start

Turn potentiometer „M“ clockwise so far that, when pressing the ON-key, the motors starts immediately. In this connection, humming with the motor being at rest is to be avoided.

Adjust potentiometer „t“ so that the requested starting time or starting characteristic is reached.

**Note:** To protect the power semiconductors and the motor from excessive heating, the starting time is to be kept as short as possible. At any rate, the motor **must** have reached its nominal speed before the bypass is activated („bypass“-LED is illuminated).



### Warning:

If the adjusted acceleration time is too short, the internal bypass contacts close **before** the motor has reached nominal speed. This can cause damage to the bypass relays.

### Adjusting the braking current

The braking current is to be adjusted to a value as small as possible in order to avoid unnecessary heating of the power semiconductors and the motor. This is especially important in the case of high switching frequencies. We recommend to limit the maximum braking current to 2.5 times the rated motor current.

The requested braking torque is to be adjusted with the potentiometer „I“. It is important that the braking current does not exceed the rated device current which is indicated on the rating plate of the device.

### Adjusting the braking time

It is not necessary to make an adjustment, since the braking current is automatically switched off approx. 1.5s after the motor has come to a standstill.

If during the maximum braking time (10s in the case of standard devices) no standstill is detected, the braking current will be switched off after this period of time. This is indicated by an opening of the fault signaling contact. The red „fault“-LED is illuminated.



### Caution: Danger to life through electric shock!

Even if the motor is at rest, it is **not** physically separated from the mains.



**Adjusting the standstill threshold**

Before the first start the potentiometer „n0“ must turn to left stop.

If the braking current switches off before the motor has come to a standstill, turn the potentiometer in 0,5 steps from „n0=0“ to be found a setting which switches the braking current after the motor has come to a standstill.

After the motor has come to a standstill the braking current switches off approx. 1,5 s.

**Note:** The positioning of the braking current as the braking can affect that the motor standstill is not properly detected. Then control the switched off the braking current by a second braking.

**Warning!**

It must be ensured that the specified switching frequency is not exceeded, otherwise the motor may overheat.

---

## 10. Dimensioning of pre-fuses

The pre-fuses F can be dimensioned by means of the following instructions.

Basically, two types of fuse protection are available for the user.

1. Fusing according to allocation type „1“, DIN EN 60947-4-2.  
After a short circuit, the device is allowed to be inoperative and repair work is possible.
2. Fusing according to allocation type „2“, DIN EN 60947-4-2.  
After a short circuit, the device must be suitable for further use. However, there is the danger that the contacts of the bypass or braking relays weld. Therefore, if possible, these contacts are to be checked prior to reconnecting the device to the mains supply. If this check cannot be carried out by the user, the device has to be returned to the producer in order to have it checked.

The following dimensioning information refers to the below operating conditions:

- Use of standard asynchronous motors
- Standard starting and/or braking times
- Switching frequency not exceeding the value indicated in the data sheet

### Fusing according to allocation type „1“:

As pre-fuses, we recommend to use line protection fuses (utilization category gL) or automatic circuit-breakers with type K tripping characteristic. In the case of automatic circuit-breakers, the tripping characteristic of the type series is to be taken into account when protecting the soft start section. With  $2 \times I_n$  the tripping time should be at least 20s ( $I_1$ ).

Taking into account the maximally occurring starting current (normally up to the 5-fold rated device current of the starting section) and the maximally occurring braking current (normally the rated device current of the braking section), we recommend fuse values according to table 1, column 4 for the starting section, and column 5 for the braking section.

In the case of special devices having increased starting or braking times, the recommended fuse value may have to be adapted.

**Note:** Wiring cross-sectional area according to DIN VDE 0100-430,  
DIN EN 57100-430.

---

**Fusing according to allocation type „2“:**

The power semiconductors are to be protected by fuses of the utilization category gR (semiconductor protection fuses, high-speed fuses). However, since these fuses do not ensure line protection, it is necessary to use additionally line protection fuses (utilization category gL).

To protect the semiconductors it is necessary to select gR-fuses featuring cutoff- $I^2t$ -values which are approx. 10-15% below the  $I^2t$ -value of the power semiconductor (see technical data).

In this connection the fuse rating of the selected fuse should not be smaller than the starting current to be expected for the soft start section and the braking current to be expected for the braking section.

**PETER electronic does not prescribe the use of semiconductor protection fuses.**

**Note 1** On the basis of the  $I^2t$ -value of the power semiconductors, the starting time, possibly the max. starting current, braking time, braking current and switching frequency, the fuse supplier is able to select a suitable type. Due to the great variety of producers, sizes and types, PETER electronic does not recommend any particular fuses.

**Note 2** If the value of the fuse or the cutoff- $I^2t$ -value is selected too small, it may happen that the semiconductor fuse reacts during the starting phase or during braking.

Column 1	Column 2	Column 3	Column 4	Column 5
Rated device current Start. section	Rated device current Brak. section	Device type	Starting section Fuse value in the case of allocation type 1	Braking section Fuse value in the case of allocation type 1
12A	25A SO9 = 45A	VCII 230-3 VCII 400-5.5	20A	20A SO9 = 35A
15A	35A SO9 = 60A	VCII 230-4 VCII 400-7.5	25A	25A SO9 = 40A
25A	45A SO9 = 75A	VCII 230-5,5 VCII 400-11	35/40A	35A SO9 = 50A
32A	55A	VCII 230-7,5 VCII 400-15	50A	40A

Table 1

### 10.1 Note on UL/cUL-requirements

To meet the UL-requirements, the VersiComb II has to be connected to the mains voltage via a `circuit breaker` having an overload release up to  $I_r = 50A$  (e.g., Moeller NZMB2-AF50-NA) or via a `combination motor controller Type E` featuring an overload release up to  $I_r = 32A$  (e.g., Moeller BK25/3-PKZ0-E + PKZM0-32).

The mains voltage may have a maximum input voltage of up to 480V AC and a short-circuit current intensity up to 5000 A.

## 11. Installation guideline

The VersiComb II is to be installed according to the attached connection diagram. For other connections please consult PETER electronic GmbH & Co. KG.

**Note:** Further connection diagrams for special circuit arrangements are available on our homepage at [www.peter-electronic.com](http://www.peter-electronic.com).

**Note:** Prior to putting the VersiComb II into operation, the wiring is to be checked.

### 11.1 Dimensions

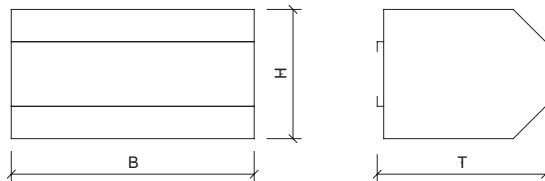

Mounting dimensions	B	H	T
VC II 400-5,5...15	166	106	117

All dimensions are indicated in mm.

11.2 General connection diagram

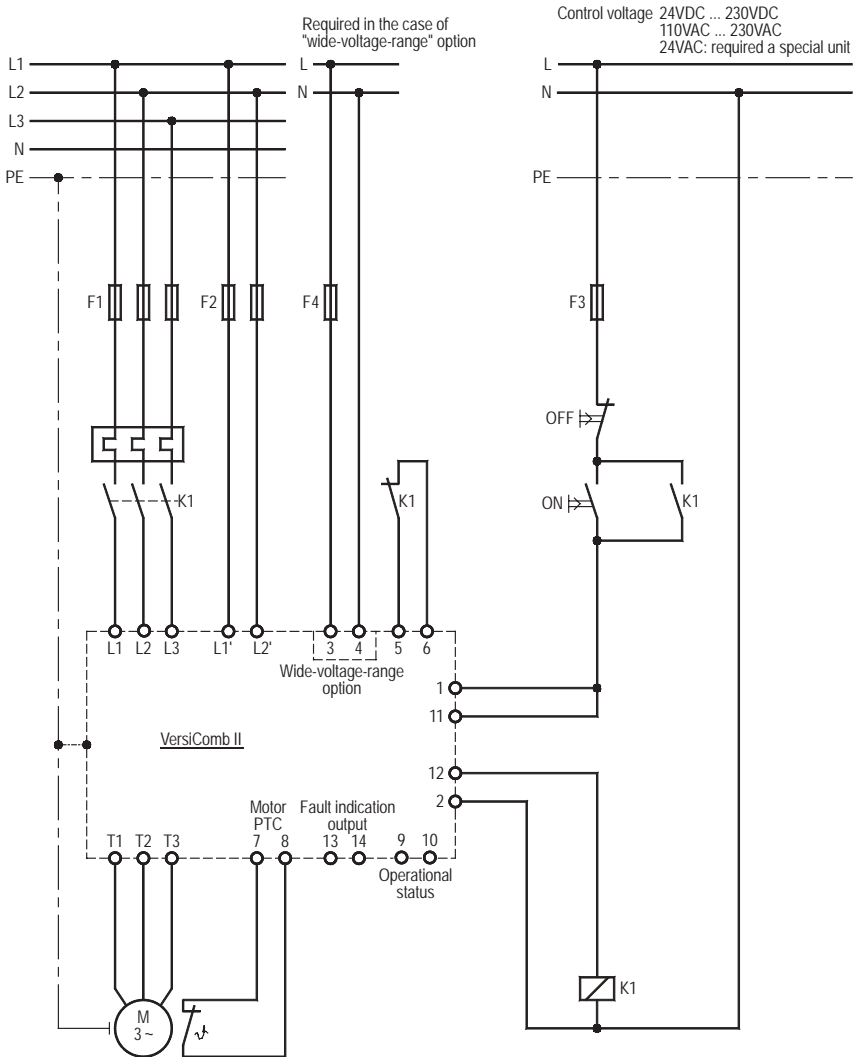

**11.3 Connection diagram for special devices VCII 480...B SO9/24VAC**

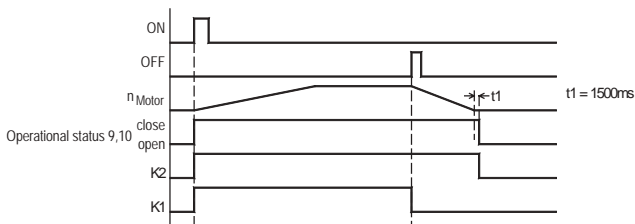
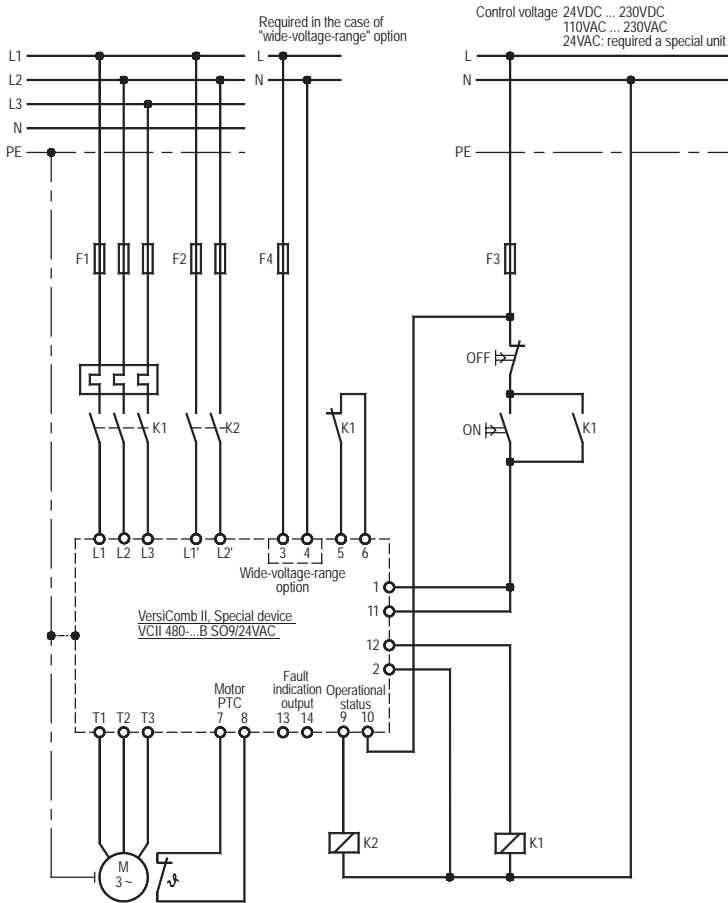











[www.peter-electronic.com](http://www.peter-electronic.com)

