

Assembly and Commissioning Instructions
Softstarters
DUOSTART 1,5 ... 5,5

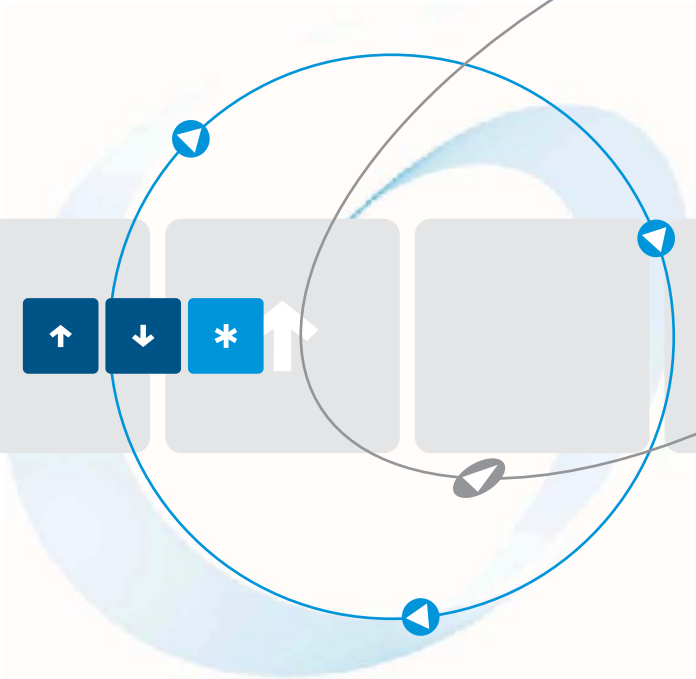

as per 04/10 11500.10001

Table of Contents	Page
1. Safety notes	3
2. Conformity	3
3. General description	4
4. Usage to the intended purpose	4
5. EC Declaration of Conformity	5
6. Block diagram	6
7. Commissioning	6
7.1 Mounting instructions	7
7.2 Connection	7
7.3 Parameter adjustments	10
8. Operational indications, Monitoring outputs	11
8.1 Operational indications	11
9. Technical data	12
9.1 Environmental conditions	12
9.2 Options	12
10. Dimensioning rules	13
10.1 Dimensioning of pre-fuses	13
11. Installation guideline	14
11.1 General connection diagram	15
11.2 Typical connections	16
12. Dimensions	17

These commissioning instructions were prepared with great care. Nevertheless, PETER electronic GmbH & Co. KG does not assume liability for damage resulting from mistakes possibly contained in this manual. Technical changes that serve to improve the product are subject to change without notice.

Notes and symbols used in these instructions

Note: Notes explain the advantages of certain adjustments or settings and help you to make use of the device in the best possible way.



Warning notices: Read them carefully and follow them strictly!

Warning notices are indicated in order to protect you against danger or to help you to prevent the device from being damaged.



Caution: Danger to life through electric shock!

When you see this sign, always make sure that the device is de-energized and secured against unintentional energizing.

1. Safety notes



The described devices are electrical equipment for use in industrial electrical power installations. An impermissible removal of the covers during operation can cause serious damage to your health, since these devices contain live parts with high voltages.

Adjustment work may only be performed by trained staff observing the safety regulations. Assembly and mounting work may only be carried out with the equipment deenergized.

Make sure that all drive components are properly earthed.

Please read these commissioning instructions carefully before putting the device into operation.

Besides, the user must ensure that the devices and associated components are fitted and connected in accordance with the applicable local, legal and technical regulations. The VDE-regulations VDE 0100, VDE 0110 (EN 60664), VDE 0160 (EN 50178) , VDE 0113 (EN 60204, EN 61310), VDE 0660 (EN 50274) plus the appropriate regulations of the TÜV (Technical Control Association) and the trade associations apply in Germany.

The user must ensure that the drive turns into a safe operating state following a device failure, in the event of maloperation, or if the control unit has failed etc..

Caution: Even if the motor is at rest, it is **not** physically separated from the mains.

2. Conformity

In industrial linguistic usage the drive controllers of the type series DUOSTART are called "devices", however, in the sense of the "law on the safety of equipment", the "EMC-law" or the "EC-machinery directive" they are not devices or machines ready for use or connection but they are components. It is only possible to define their final function, when these components are integrated into the design and construction of the user.

To be able to use the devices to their intended purpose, it requires power supply networks according to DIN EN 50160 (IEC38).

The user takes the responsibility that the user's design and construction comply with the applicable legal provision.

The commissioning is strictly forbidden as long as the conformity of the final product with the guidelines 2006/42/EC (Machinery directive) and 2006/95/EC (Low voltage directive) is not proved.

3. General description

In the case of the soft starters of the DUOSTART-type the motor voltage is changed in two phases (1L1/5L3) by means of a generalized phase control and power semiconductors. Starting from an adjustable start trigger angle the trigger angle is continuously reduced. During the adjusted ramp-up time the motor torque increases according to a ramp function until the maximum value is reached. When the acceleration time is over, the power semiconductors are bypassed by integrated relays and the motor is directly supplied from the mains.

After the start/stop-contact has opened, the trigger angle is continuously increased via a ramp function, and thus, the motor is softly slowing down.

The acceleration time, the starting torque and the deceleration time can be separately adjusted with a potentiometer each.

The acceleration or deceleration is effected by closing or opening the contact on the terminals X1/X2.

The power unit supplies the voltage for the control electronics. Upon request, the power supply can also be implemented by means of an external power supply unit (24V min 100mA DC or AC).

4. Usage to the intended purpose

The devices of the DUOSTART-series are electrical equipment that is used in industrial electrical power installations. They are designed for the application in machines, in order to reduce the starting torque or the inrush peaks and the soft stop torque of drives with three-phase motors.

Typical Applications:

- door and gate drives
 - pumps, ventilators
 - conveyers
 - packaging machinery
 - transformer soft start
-

5. EC Declaration of Conformity



EC Declaration of Conformity 

The manufacturer / company placing the product on the market
(authorized representatives of the manufacturer / companies placing the product on the market
that are established within the Community)

Name / Address: Peter Electronic GmbH & Co.KG
Bruckäcker 9
92348 Berg
Germany

hereby declares that the following product (device, component, unit) in the version as supplied

Product designation: Softstarter
Serien / type designation: DUOSTART 1,5 ... 5,5
Article group: 215...
Year of manufacture: 1998

complies with the provisions of the following EC-directives:

2004/108/EG concerning Electromagnetic compatibility and **2006/95/EG** concerning Electrical equipment designed for use within certain voltage limits

The following harmonized standards have been applied:

EN 60947-1: 2008	Low-voltage switchgear and controlgear General rules	EN 60947-4-2: 2007	Low-voltage switchgear and controlgear Contactors and motor-starters - AC semiconductor motor controllers and starters
------------------	---	--------------------	---

This EC Declaration of Conformity is no longer valid, if the products is modified or changed
without our agreement.

This declaration is issued under the sole responsibility of the signatory.

Berg, 05.08.2009 Dr. Thomas Stiller, Managing Director
(place, date) (signatory and function of the signatory)

(signature)

6. Block diagram

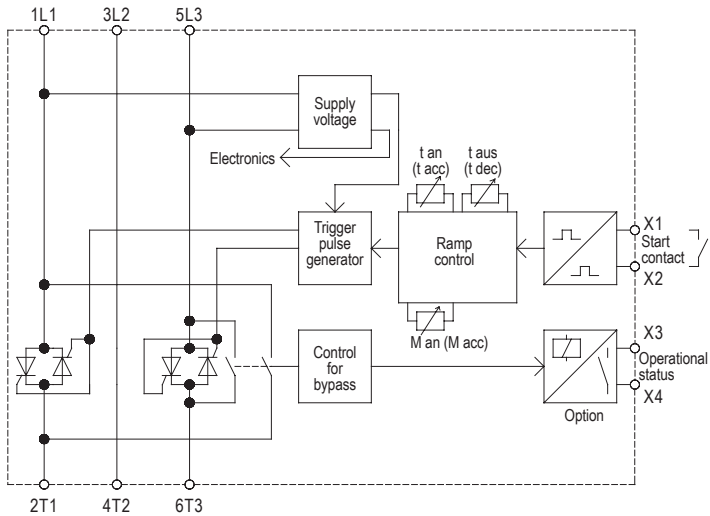

7. Commissioning

The device is to be put into operation in 3 steps:

1. Mounting
2. Connection and
3. Parameter setting

7.1 Mounting instructions



Caution: Danger to life through electric shock!

The following conditions are to be complied with in order to ensure a safe and reliable operation of the DUOSTART.

1. The device series DUOSTART is to be used under conditions of the overvoltage category III.
2. Make sure that pollution degree 2 or better, in accordance DIN EN60644-1 / IEC664, is complied with.
3. The device has to be installed into a housing (min. degree of protection: IP54).
4. The device must be operated without being exposed to contamination by water, oil, carbon deposits, dust, etc..

Note: The device has to be fitted on a vertical mounting surface, with the control terminals facing downwards. Make sure that no additional heat sources, such as resistors etc. are placed underneath the device.



Warning:

To avoid heat concentrations, a distance of at least 40mm is to be kept between cable duct and device.

The devices can be mounted directly side by side.

The devices are to be snap-mounted onto a 35mm top-hat rail according to DIN EN 50022.

7.2 Connection

power unit (see also connection diagram)

The device is to be installed according to the attached connection diagram. For other connections refer to the factory.

Note: Prior to putting the DUOSTART into operation the wiring is to be checked. Only connect the device according to the attached connection diagram.

The mains, motor, and control lines are to run in separate cables. In the case of long cable lengths, the control leads should be laid with shielding. If the drive is to fulfil the radio interference suppression level "N", a filter of the appropriate rating (see "Technical data") is to be integrated in the mains cable as close as possible to the device.

Terminals power unit

Terminal 1L1:	Mains voltage L1
Terminal 3L2:	Mains voltage L2
Terminal 5L3:	Mains voltage L3
Terminal 2T1:	Motor terminal U
Terminal 4T2:	Motor terminal V
Terminal 6T3:	Motor terminal W

Control unit

Terminal X1:	Control input
Terminal X2:	Control input
Terminal X3:	Control output - optional
Terminal X4:	Control output - optional

Control setting

The DUOSTART devices will be controlled alternative in two control modes.

1. Start/Stop through contact or switching transistor (standard)
2. Start/Stop through control voltage 10 ... 42VDC

The devices DUOSTART 1.5 ... 5.5 can be switched over by re-arranging a jumper. For this purpose the central board has to be snapped out of the upper part of the housing. Between the left-hand and the central potentiometer there is the 3-pole jumper-plug „BR1“. The jumper is factory-plugged to „Cantact“ position (front plug-in position). If you plug the jumper into „Voltage“ position, the control with 10 ... 42VDC is possible.

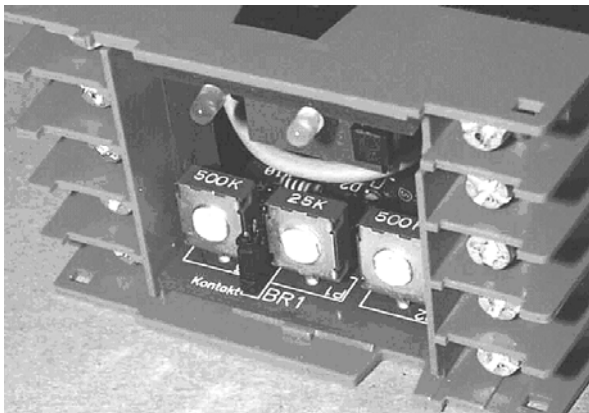

Control via contact

Contact for acceleration or deceleration
Contact loading 12VDC/15mA

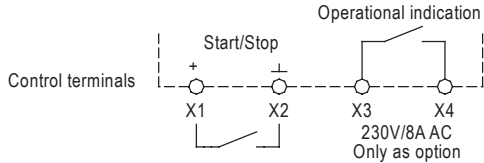

If a contact is closed across terminals X1 and X2, the motor starts with the adjusted ramp-up time. When the contact is open, the motor runs down with the adjusted ramp-down time. The motor, however, is not physically separated from the mains.

Optionally, the control input can also be set for a control by means of d.c. voltage (see „control setting“ page 8)



Caution: Danger to life through electric shock!

The terminals X1 and X2 carry mains potential; therefore, the connected contact must be potential-free.

If only soft starting is required, the DUOSTART can also be controlled via the main contactor. For this purpose the terminals X1 and X2 have to be jumpered.

Control with d.c. control voltage (e.g., SPC).

Control voltage
e. g. from an SPC
10...42V

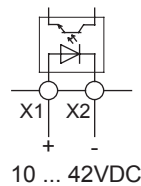

10 ... 42VDC

If d.c. voltage is applied to the terminals X1 and X2, the motor will run up with the adjusted acceleration time. If the control voltage is removed, the motor will run down with the adjusted deceleration time.

7.3 Parameter adjustments

3 potentiometers that enable the following adjustments are located on the front side..

Parameter	Poti	Adjustment range
Breakaway torque	M_{acc}	0...80% Poti turned to right stop = maximum torque
Acceleration time	t_{acc}	Acceleration time adjustable from 0.5...12sec Poti turned to right stop = longest acceleration time
Deceleration time	t_{dec}	Deceleration time adjustable from 0.5...12sec Poti turned to right stop = longest deceleration time

Note: To avoid damage to the device or machine components when making adjustments, it is, prior to the first connection to the mains, recommended to adjust the potentiometers as follows:

Potentiometer M_{acc}	(breakaway torque)	= left stop
Potentiometer t_{acc}	(acceleration time)	= mid-position
Potentiometer t_{dec}	(deceleration time)	= left stop

Adjusting soft start

1. Switch on the DUOSTART and select soft start.
2. Turn the potentiometer M_{acc} clockwise so far that the motor starts up immediately. Avoid unnecessary humming when the motor is at rest.
3. Adjust the potentiometer t_{acc} until the required acceleration time or acceleration characteristic is reached.
4. Turn potentiometer t_{acc} counter-clockwise as far as possible!

While ensuring good acceleration characteristics, this results in short times until the bypass contactor is energized, and consequently the power semiconductors and the motor are less heated. This is particularly important in the case of high loading and many switching cycles.



Warning

If the ramp-up time is adjusted too short, the internal bypass contact closes before the motor has reached its nominal speed. This can cause damage to the bypass contactor or the bypass relay.

Adjusting soft stop

Note: In order to enable soft stop, the DUOSTART, during the deceleration phase, must remain switched on with the three-phase mains.

In the case of these devices the soft stop torque is fixed to 70%. Now, adjust potentiometer t_{dec} until the required deceleration time or deceleration characteristic is reached.



Caution: Danger to life through electric shock!

Even if the motor is at rest, it is **not** physically separated from the mains.



Warning

It must be ensured that the specified switching cycle is not exceeded!

8. Operational indications, Monitoring outputs

8.1 Operational indications

2 LEDs indicating the following operating states are located on the control board.

LED green	illuminated = device connected to mains voltage
LED yellow	illuminated = top of ramp

As an option, a signalling contact on the terminals X3 and X4 is obtainable (DUOSTART ... M), which is closed from the beginning of the soft start to the end of the soft stop. Alternatively, it may also be implemented as an operational indication for the "device bypassed" status (DUOSTART...MB).

Contact loading:	8A/250VAC per output.
Contact material:	silver-cadmium-oxide (AgCdO)

9. Technical data

Type designation	DUOSTART			
	1,5	3	5,5	
Mains / motor voltage acc. to DIN EN 50160 (IEC 38)	400V +/- 10% 50/60Hz special voltages: 220/240V 50/60Hz 460/480V 50/60Hz			
max. Motor rating (rated power)	at 230V at 400V at 460 / 480V ^a	0.75kW 1.5kW -	1.5kW 3.0kW 4.0kW	2.2kW 5.5kW 5.5kW
Rated device current		3.5A	6.5A	12
min. Motor load	40% of device rating			
Adjustment range of breakaway torque	0...80%			
Adjustment range of acceleration time	0.5 ... 12s (special times upon request)			
Soft stop torque	fixed setting to 70%			
Adjustment range of deceleration time	0.5...12s			
Repeatability	200 ms			
max. Switching cycle (3 x I _{Nenn} , 10sec)		90/h	60/h	30
Wire range	solid stranded	2.5mm ² 1.5mm ²	2.5mm ² 1.5mm ²	2.5mm ² 1.5mm ²

a. DUOSTART 1.5 is not available as 460/480V version.

9.1 Environmental conditions

Storage temperature	-25 ... 75°C
Power reduction ^a	above 45°C - 2% per 1°C up to max. 60°C and altitudes above 1000m -2% per 100m
Ambient temperature	0 ... 45°C up to an installation altitude of 1000m, not exposed to moisture condensation
Degree of protection	IP 20
Environment	Overvoltage categ. III (TT / TN-systems), pollution degree 2
Installation class	3

a. The reductions refer to rated power output.

9.2 Options

DUOSTART ... M/MB Potential-free output indicating the operational status.
Contact rating 250V / 8A AC
30V / 8A DC

10. Dimensioning rules

10.1 Dimensioning of pre-fuses

Pre-fuses F can be dimensioned according to the following instructions.

Basically, two types of fuse protection are available for the user.

1. Fusing according to allocation type „1“, DIN EN 60947-4-2.
After a short circuit, the DUOSTART device is allowed to be inoperative and repair work is possible.
2. Fusing according to allocation type „2“, DIN EN 60947-4-2.
After a short circuit, the device must be suitable for further use. However, there is the danger that the contacts of the bypass or braking relays weld. Therefore, if possible, these contacts are to be checked prior to reconnecting these contacts to the mains supply. If this check cannot be carried out by the user, the device has to be returned to the producer in order to have it checked.

The following dimensioning information refers to the below operating conditions:

- Use of standard asynchronous motors
- Standard acceleration and/or deceleration times
- Switching frequencies not exceeding the values specified in the data sheet

Fusing according to allocation type „1“

As pre-fuses we recommend to use line protection fuses (utilization category gL) or automatic circuit-breakers with type K tripping characteristic. In the case of automatic circuit-breakers the tripping characteristic of the type series is to be taken into account. With $2x I_n$ the tripping time should be at least 20s (I_1).

The fuse values are to be determined by taking the conductor cross-sectional area of the wiring into account. Depending on the rated motor current, the maximally occurring starting current (normally up to the 5-fold rated device current) and the starting frequency, the wiring cross-sectional area is to be determined. Table 1 shows the values for numerous applications, i.e., with a 3-fold nominal current as mean starting current and a max. starting time of 10s. In the case of parameter values exceeding these values, it may be necessary to adapt the fuse value accordingly.

Note: Wiring cross-sectional area according to DIN VDE 0100-430,
DIN EN 57100-430.

Fusing according to allocation type „2“:

The power semiconductors are to be protected by fuses of the utilization class gR (semiconductor protection fuses, high-speed fuses). However, since these fuses do not ensure line protection, it is necessary to use additionally line protection fuses (utilization category gL).

To protect the semiconductors it is necessary to select gR-fuses featuring cutoff- I^2t -values which are approx. 10-15% below the I^2t -value of the power semiconductor (see technical data). In this connection, the fuse rating of the selected fuse should not be smaller than the starting current to be expected.

- Note:** PETER electronic does not prescribe the use of semiconductor protection fuses. However, for some UL- or CSA-listed devices there are exceptions which are indicated in the relevant commissioning instructions.
- Note 1** On the basis of the I^2t -value of the power semiconductors, the starting time and possibly the max. starting current, the fuse supplier is able to select a suitable type. Due to the great variety of producers, sizes and types, PETER electronic does not recommend any particular fuses.
- Note 2** If the value of the fuse or the cutoff- I^2t -value is selected too small, it may happen that the semiconductor fuse reacts during the starting phase or during deceleration.

Rated device current (techn. data)	Device type	Fuse value in the case of allocation type 1	Starting frequencies Starts / h
3,5A	DUOSTART 1,5	10A	90
6,5A	DUOSTART 3	10A	60
12	DUOSTART 5,5	20A	30

Table 1

11. Installation guideline

The device is to be installed according to the attached connection diagram. For other connections please consult PETER electronic GmbH & Co. KG.

The mains, motor, and control lines are to run in separate cables that must be laid separately from each other.

Note: Further connection diagrams for special circuit arrangements are available on our homepage at www.peter-electronic.com.

Note: Prior to putting the DUOSTART into operation the wiring is to be checked.

11.1 General connection diagram

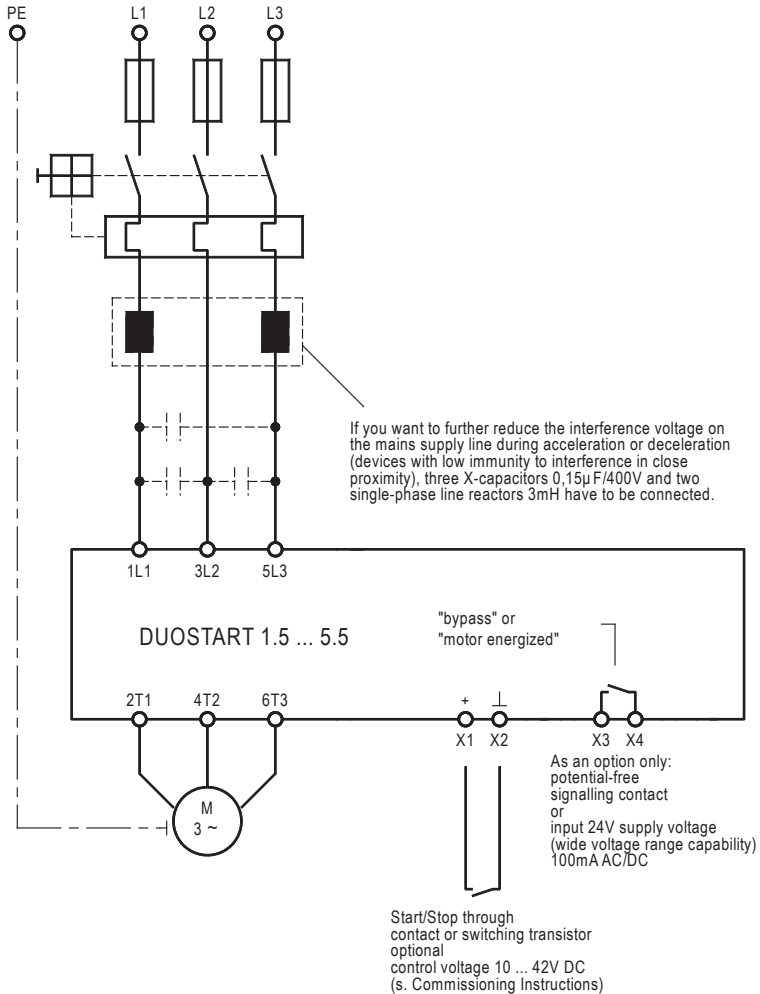

11.2 Typical connections

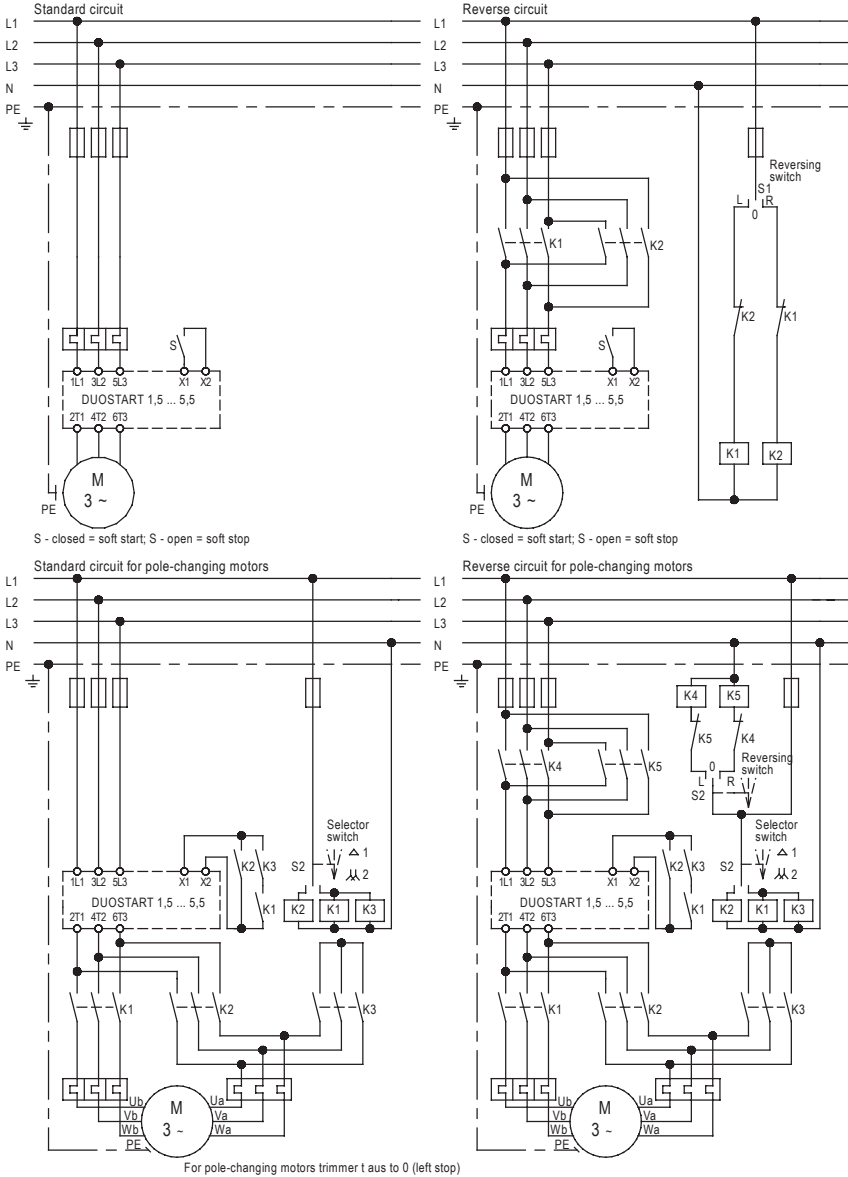

EMC

The limit values for emitted interference according to the applicable device standards do not rule out the possibility that receivers and susceptible electronic devices within a radius of 10m are subjected to interference.

If such interference, that is definitely attributable to the operation of the soft starters , occurs, the emitted interference can be reduced by taking appropriate measures.

Such measures are, e.g.:

to connect reactors (3mH) or a suitable mains filter in series before the soft starter, or to connect - capacitors (0,15µF) in parallel to the supply voltage terminals.

12. Dimensions

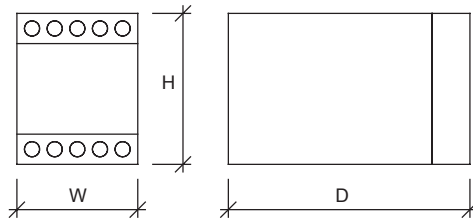

Mounting dimensions	W	H	D
DUOSTART 1,5 / 3 / 5.5	45	73	122

All dimensions indicated in mm.



www.peter-electronic.com

